

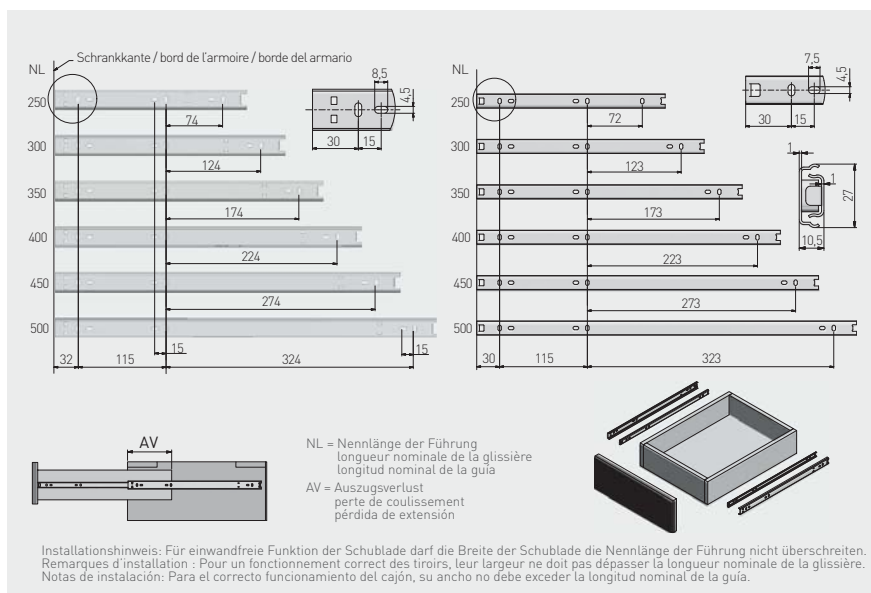







Kugelführung H27
Glissière à billes H27
Guía de bolas H27



		 L mm	 AV mm		 15		
	PK-0H27-3000	300	109	Teilauszug partielle parcial	15	verzinkt galvanisé galvanizado	Stahl acier acero
	PK-0H27-3500	350	124				
	PK-0H27-4000	400	134				
	PK-0H27-4500	450	149				
	PK-0H27-5000	500	184				

